

be certain.



Standards and Approaches for Ball Joint Durability Testing

Friday, October 24, 2008

Novi, Michigan

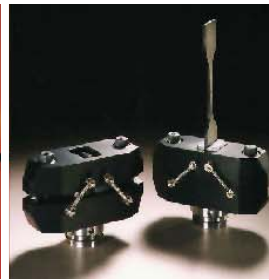

Eric Little, PhD
Sr Applications Engineer
GRV Component Test

Ball Joint Overview



Ball Joint Basics

- » Common ball joint applications
- » Types of ball joints

Inner Ball Joint

Upper Ball Joint

Tie Rod End

Lower Ball Joint

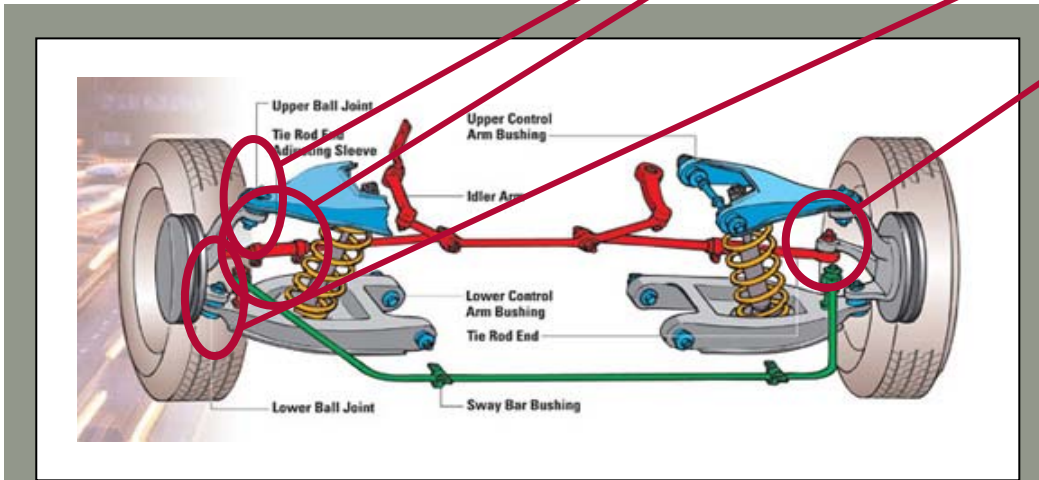

Ball Joint Components

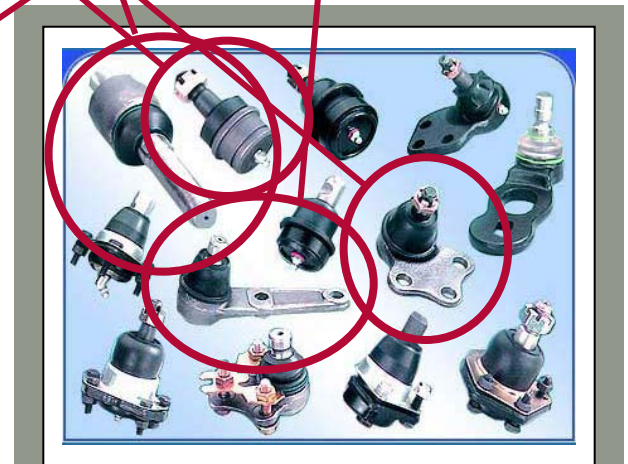

Types of Ball Joints

SAE J193 Ball Joint Tests



In general, J193 tests are uni-axial . . .

. . . except for Assy Fatigue/Heat Treat.

J193 Ball Joint Tests	MTS Capabilities
<i>Impact Strength</i>	✓
<i>Yield</i>	✓
<i>Tensile Load</i>	✓
<i>Rotation & Oscillation Torque</i>	✓
<i>Axial End Movement</i>	✓
<i>Cam-Out Strength</i>	✓
<i>Assy Fatigue and Heat Treat</i>	✓
<i>Pull-Out/Push-Out Strength</i>	✓

A multi-axial test system is required.

J193 Endurance Load Requirements



5.2.4 Ball Stud and Socket Assembly Fatigue and Heat Test

5.2.4.1 Objective – To determine fatigue and wear characteristics of ball stud and socket assemblies.

5.2.4.2.2 Phase II Test – Endurance Load: “To ***correlate*** the cycle life of the assembly for the ***average load*** to which the assembly will be subjected in application and environment, with life ***in actual use . . .***”

The Goals:

- Determine ball joint loads experienced during service life.
- Translate those loads into an easily-reproducible laboratory test.

J193 Loading and Cycle Life Criteria



Comments on Loading/Cycle Life from J193

- » “The loading use in the test procedures should be as representative as possible in magnitude and direction with loads encountered in the design application.”
- » “Using a vehicle . . . a program loading procedure can be utilized to obtain a more realistic loading assessment.”

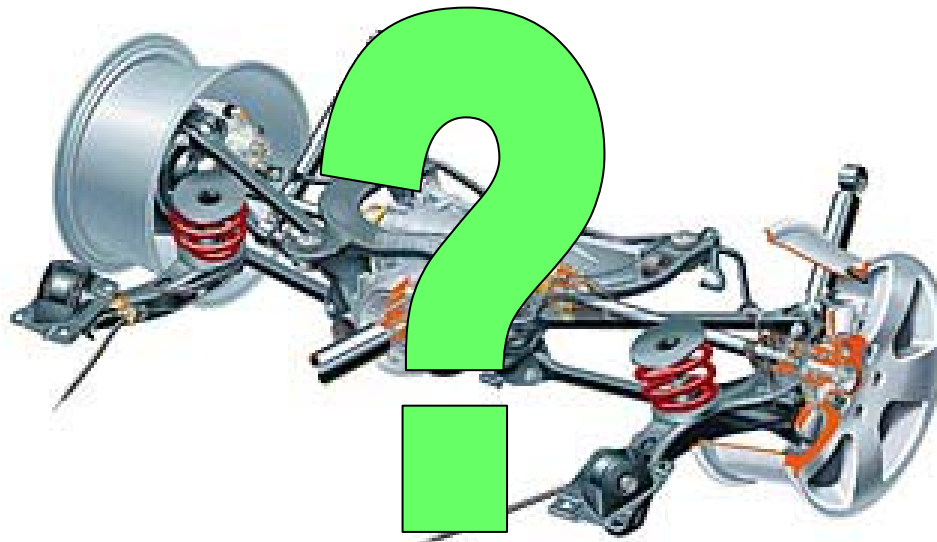

Focus: Front Lower Control Arm

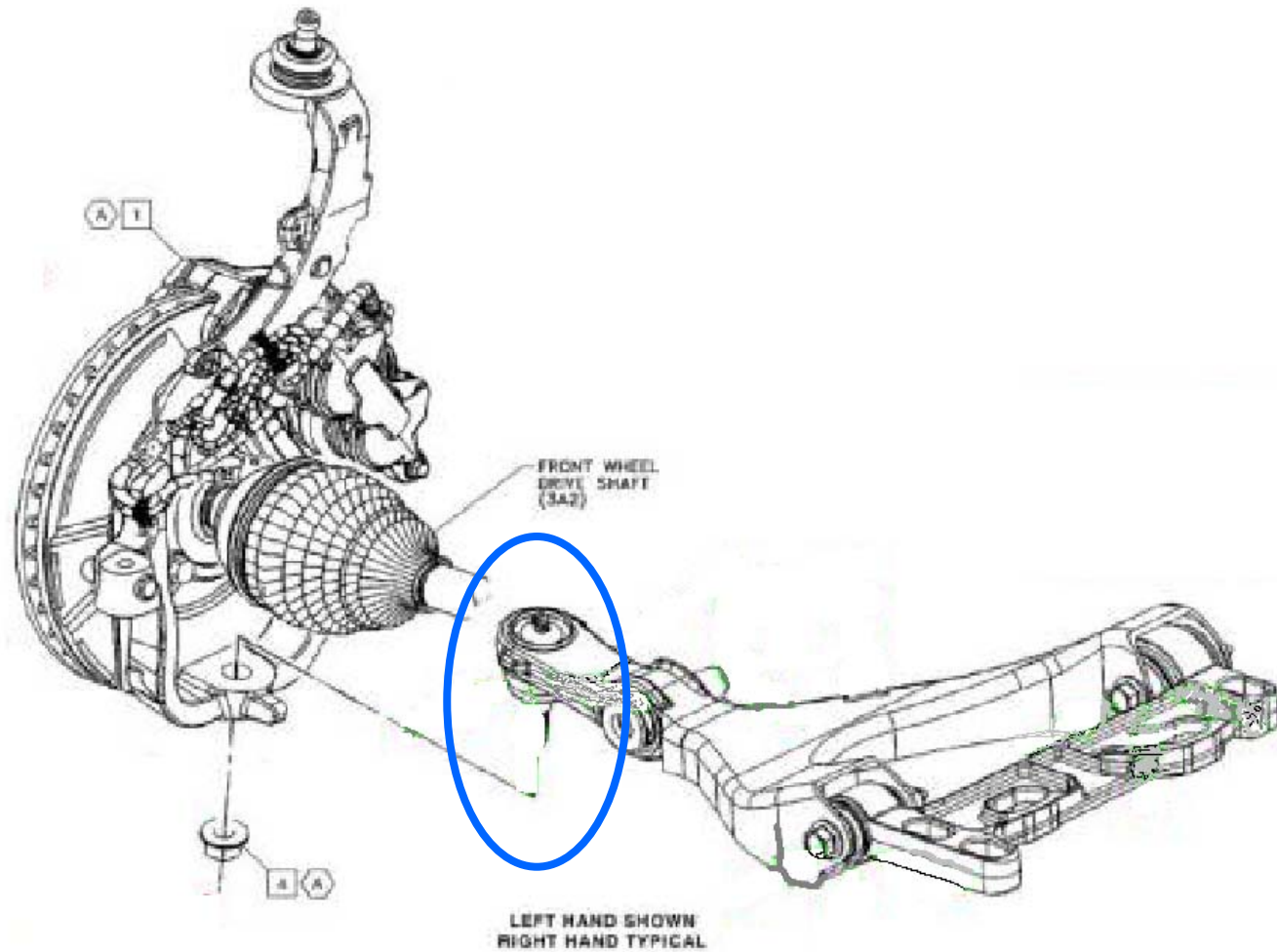

What is the Loading Environment?

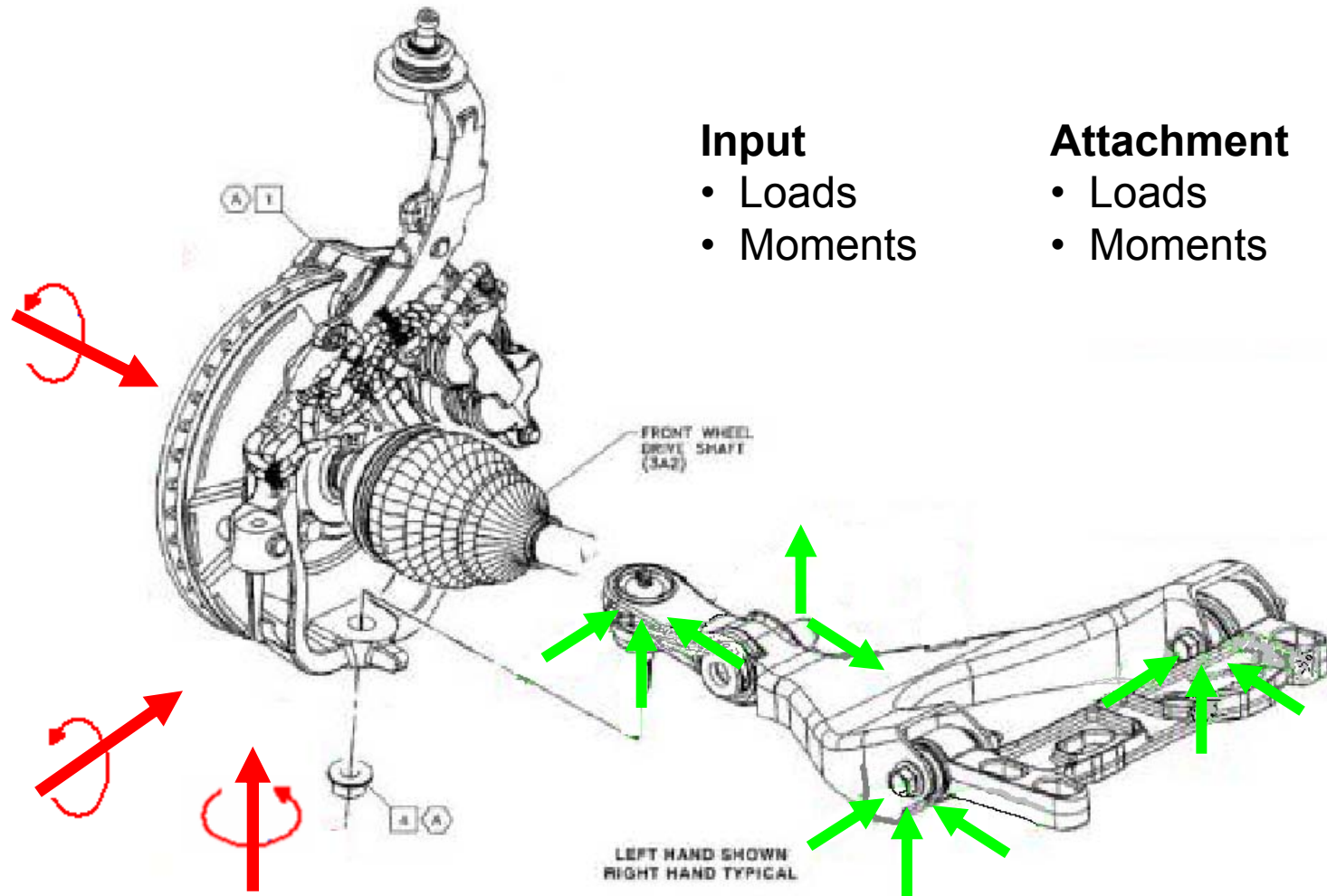

Input

- Loads
- Moments

Attachment

- Loads
- Moments

What is the Loading Environment?

Strain Gauged Ball Joint

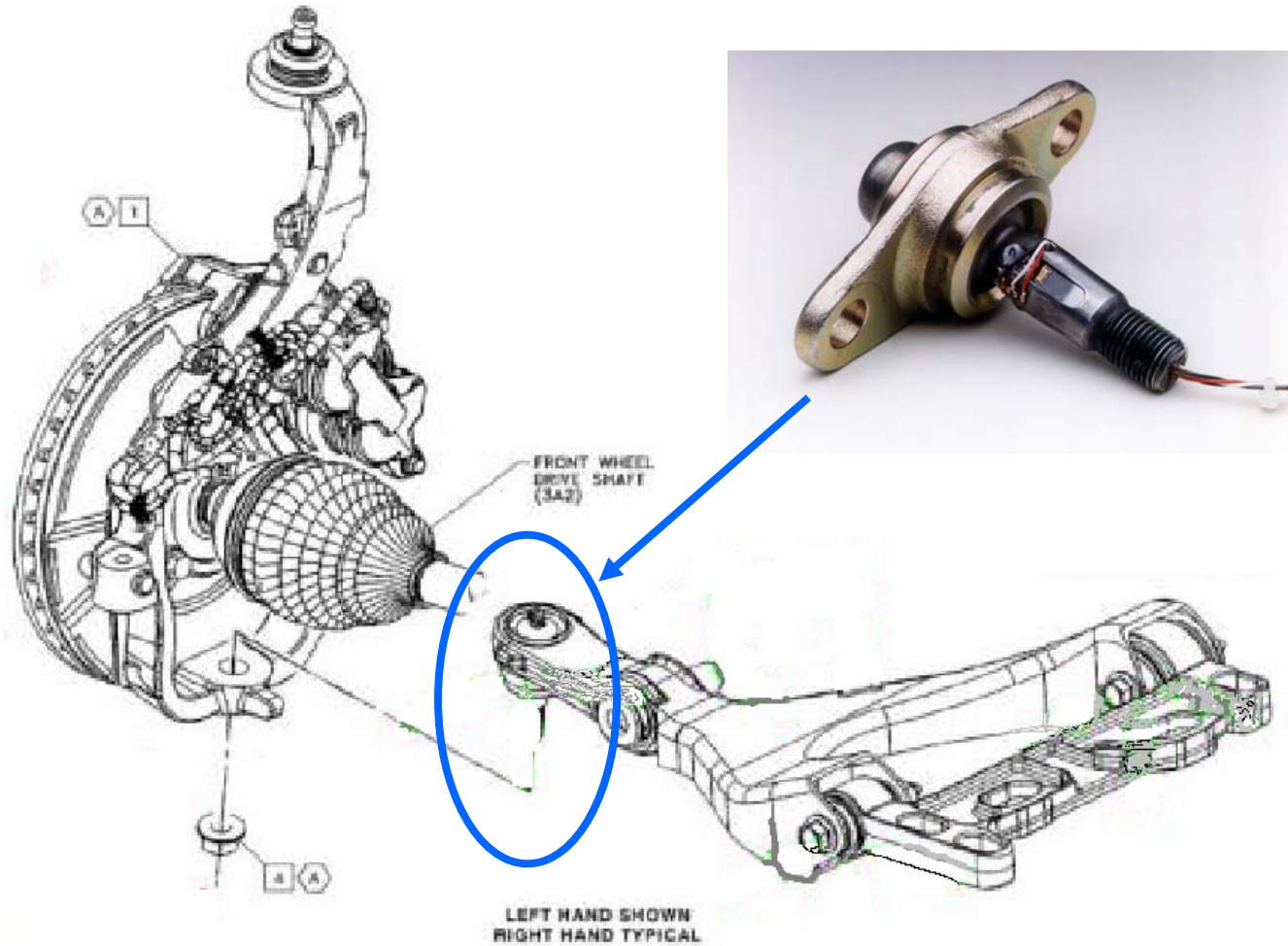

Test Planning – Peak Valley Slicing

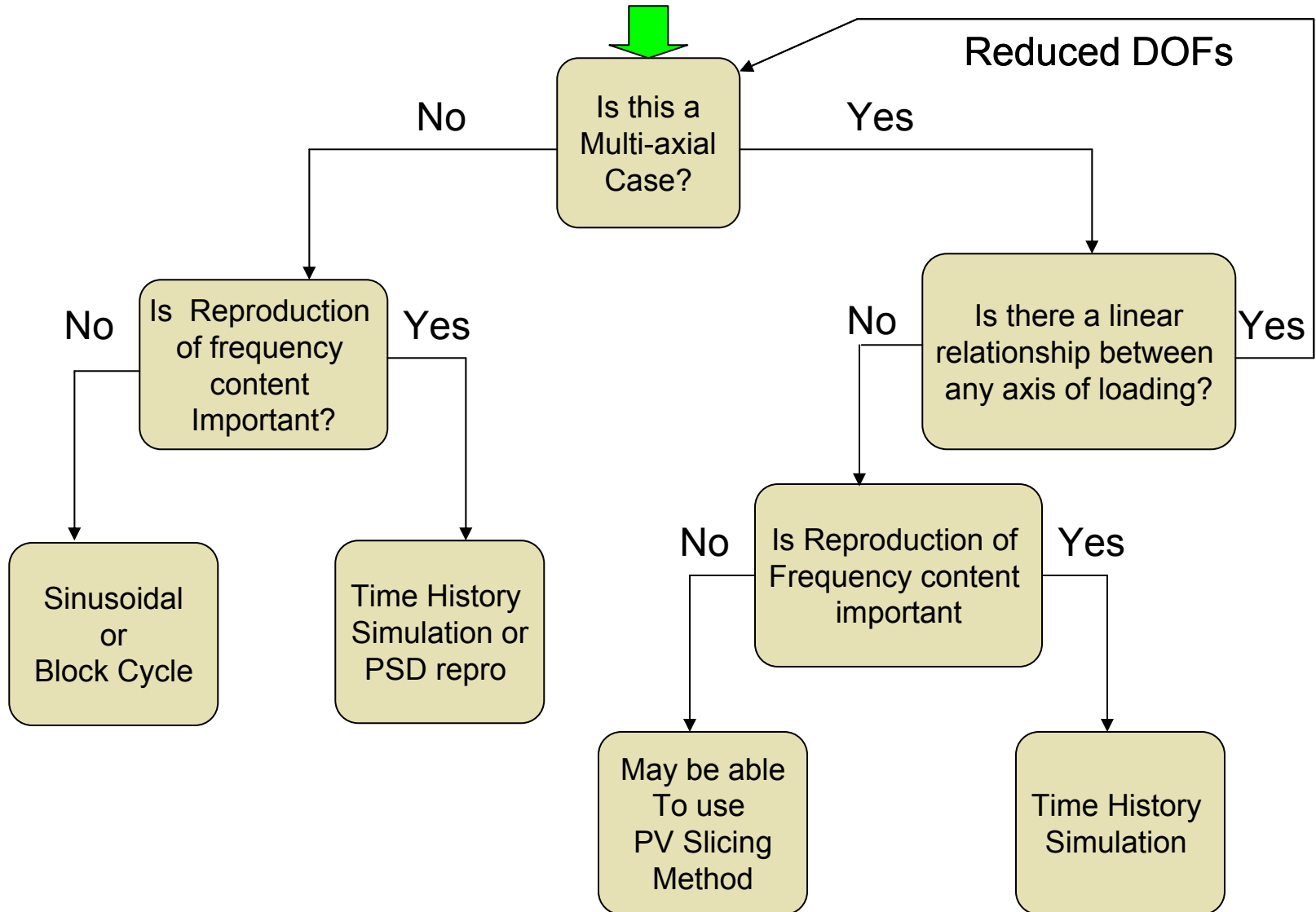

Peak Valley Slice Technique

Multi-axial case

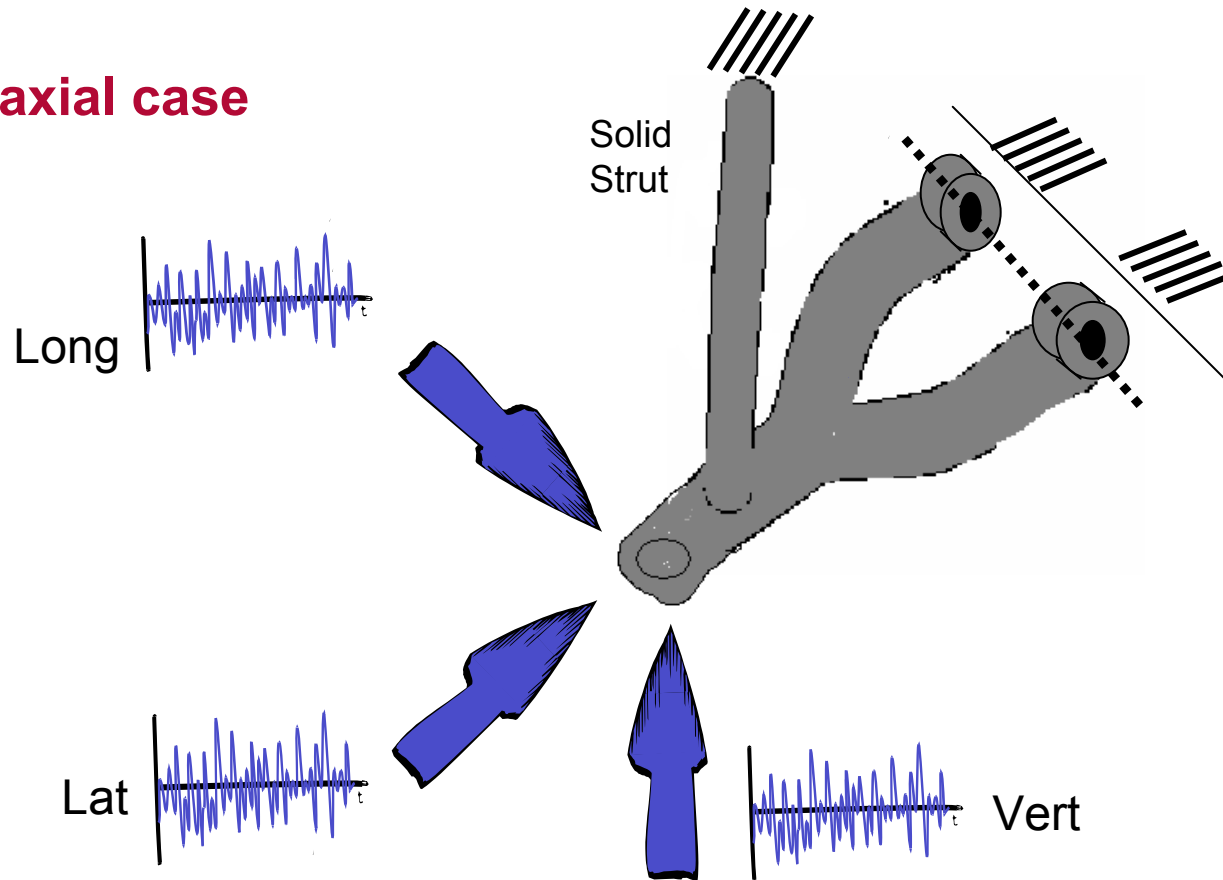

**Phasing between Vertical, Lateral & Long Inputs is critical;
frequency reproduction is not important**

Peak Valley Test Methodology



Peak Valley Slice Test Method

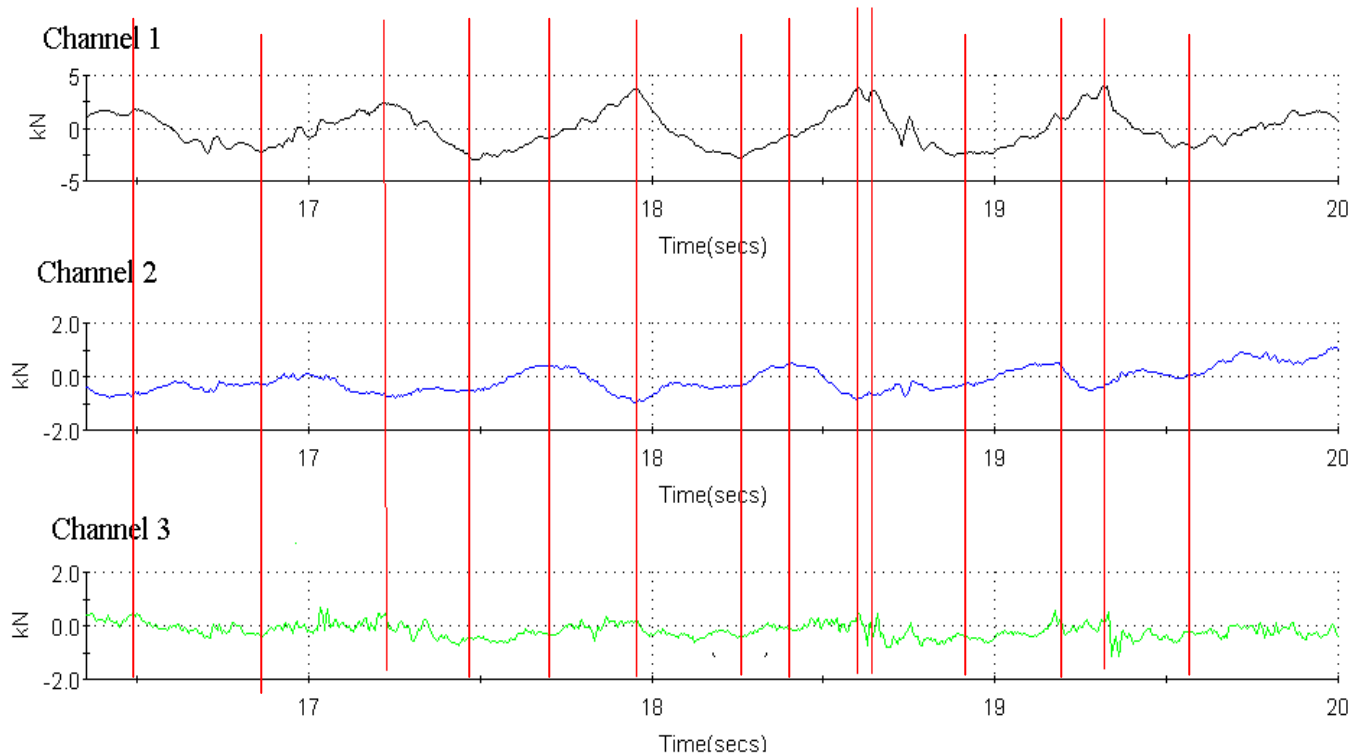

Identify Peak/Valley pairs in multi-channel data.

Peak Valley Slice Test Method



5 kph Braking events

Raw Time History = 40 sec

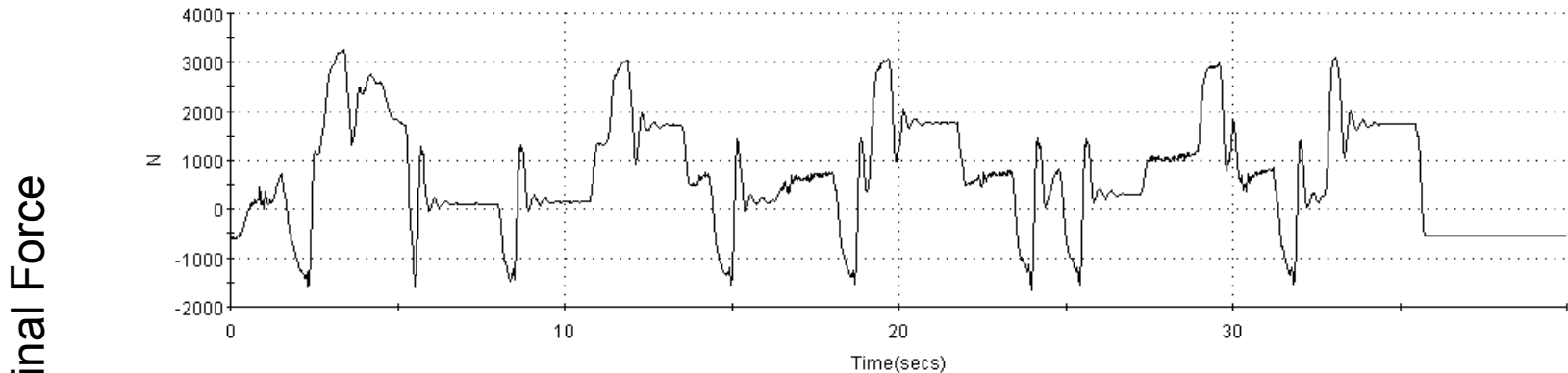

PV Time History = 10 sec

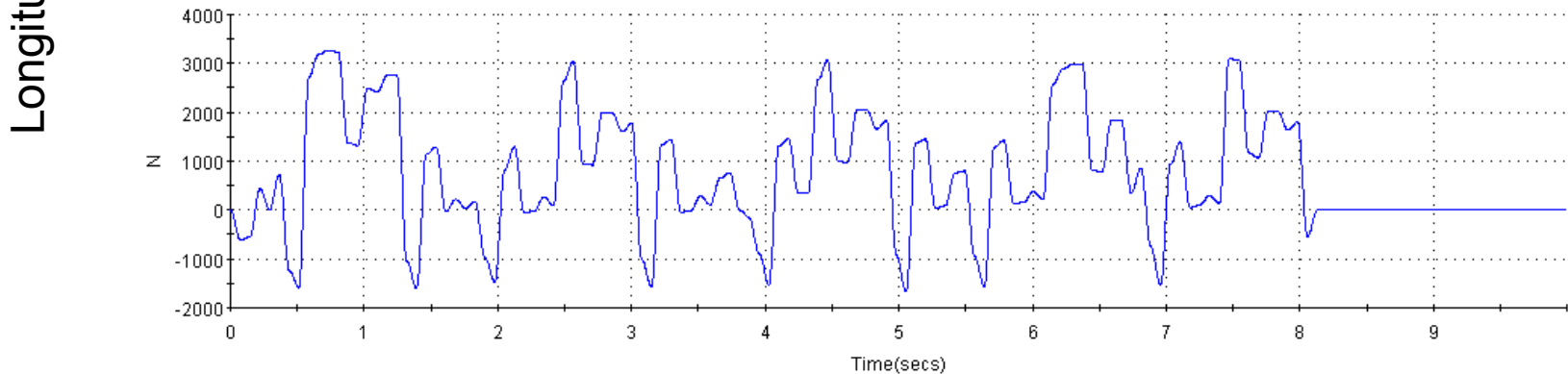

Benefit: Speed up “slow” events

Peak Valley Slice Test Method



Pothole Strike Reproduction

Raw Time History

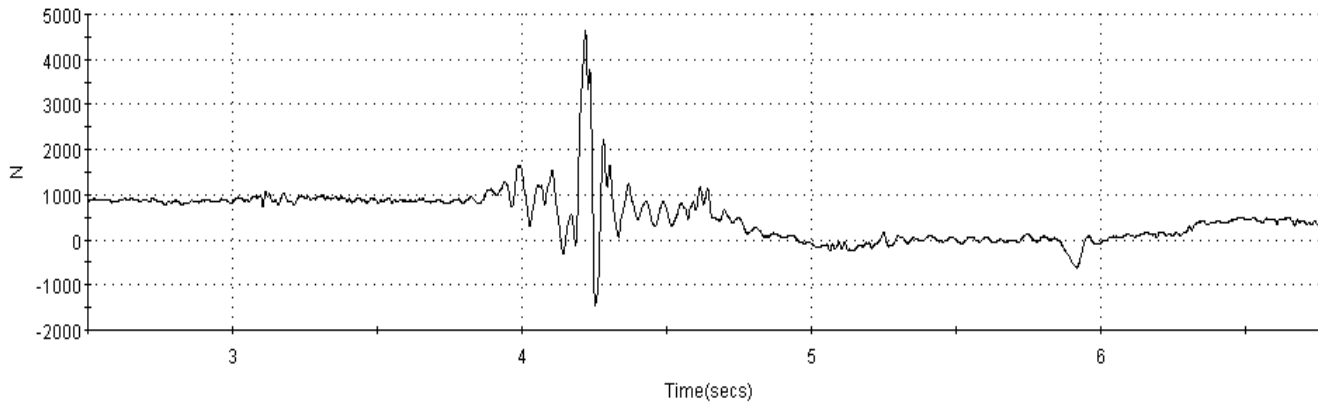

Longitudinal Force

PV Time History

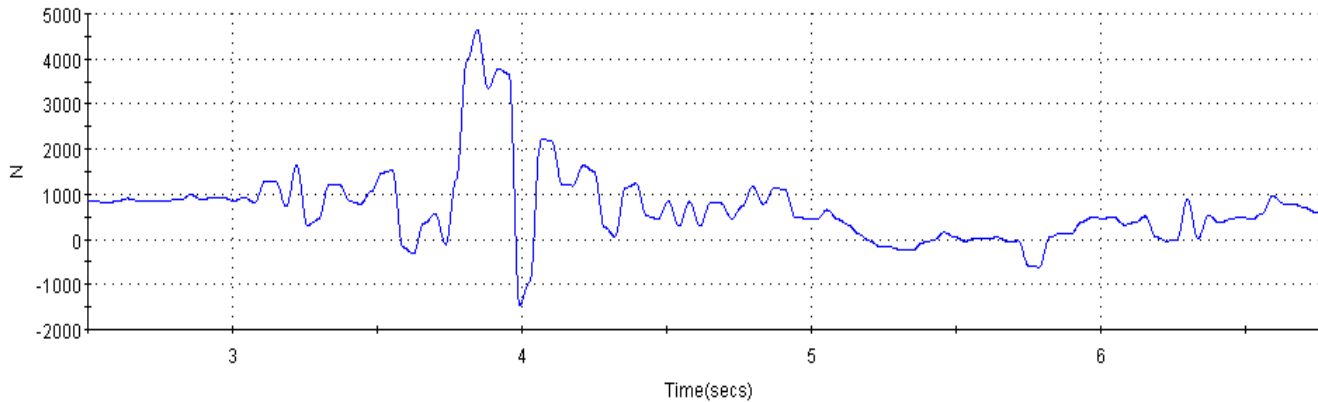

Benefit: Slow down "fast" events

Peak Valley Slicing



Benefits of PV Slicing

- » Applies accurate max/min displacements to specimens.
- » Ensures phase relationships between peak loads are maintained.
- » Can reduce test time.
- » More representative damage accumulation than block cycle testing.

When PV Slicing is not applicable

- » Elastomeric or components with frequency-dependent characteristics.

Test Planning – Time History

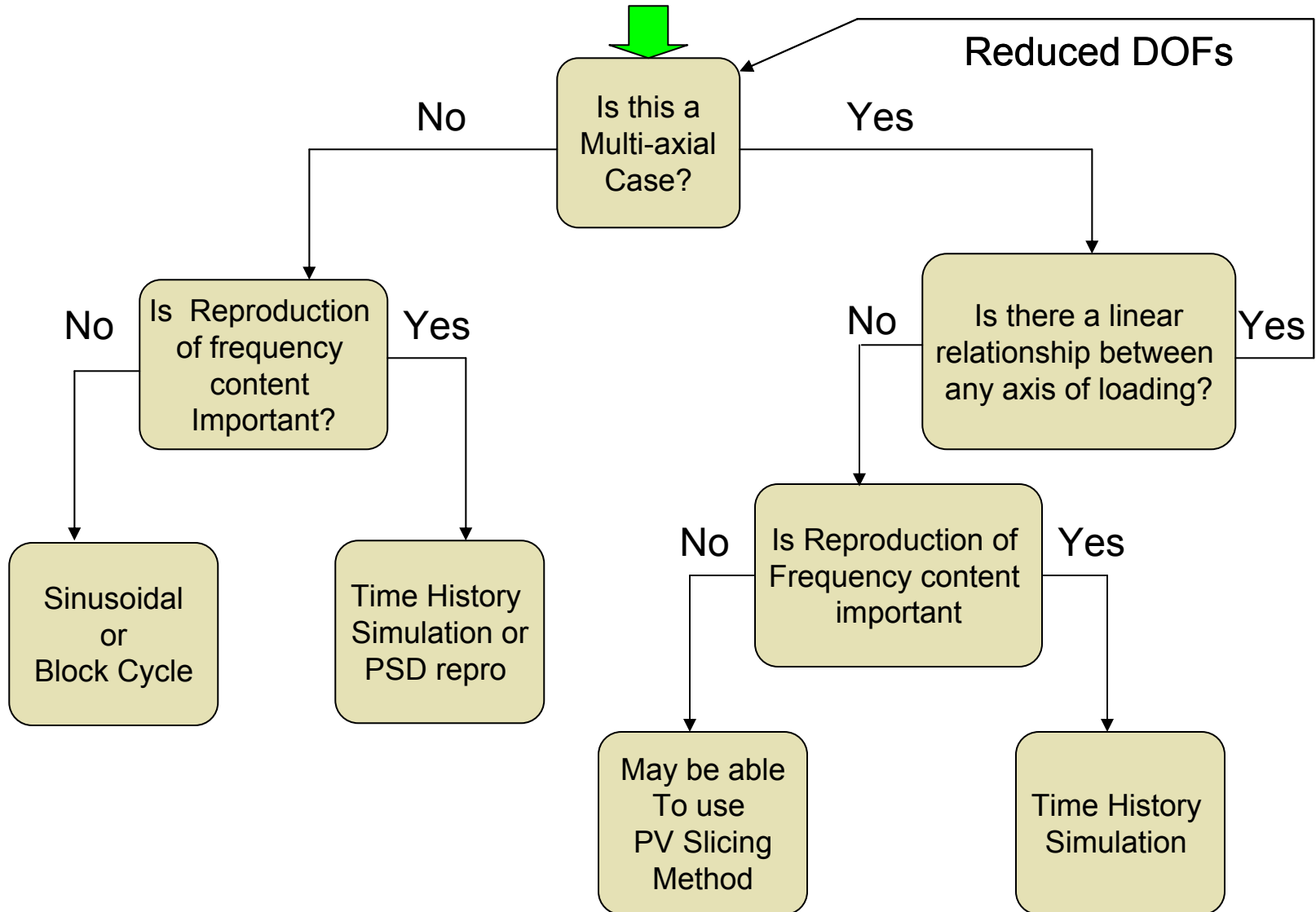

The RPC Process – Typical Correlation



Iterations – example response data

Desired, Response and Error Time Histories

- 1-Chatter_DES_DISPLAY, 9, MzL
- 2-Chatter_8_RFL, 9, LF Mz
- 3-Chatter_8_EFL, 9, MzL

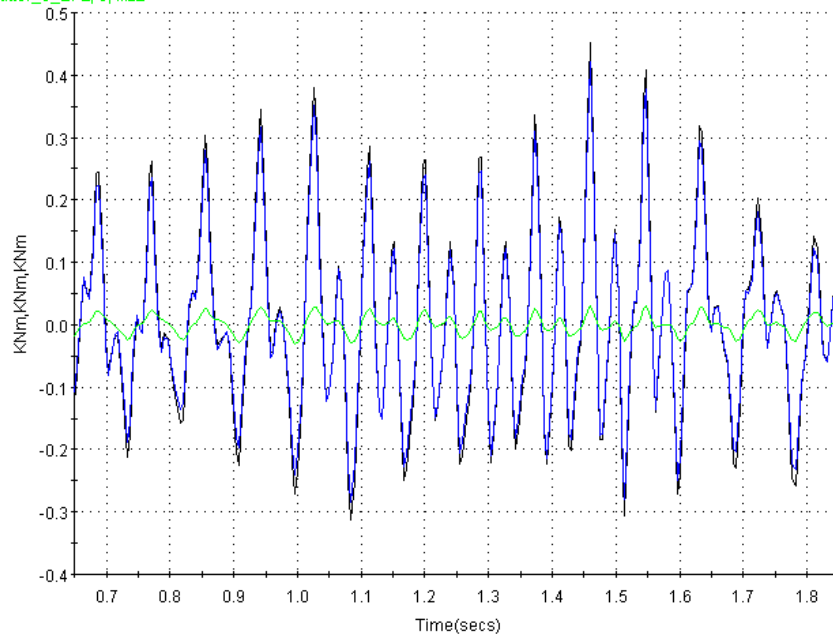

Simulation results are typically evaluated in the time, frequency, and statistics domains; often times fatigue is also used.

Desired, Response and Error ASD

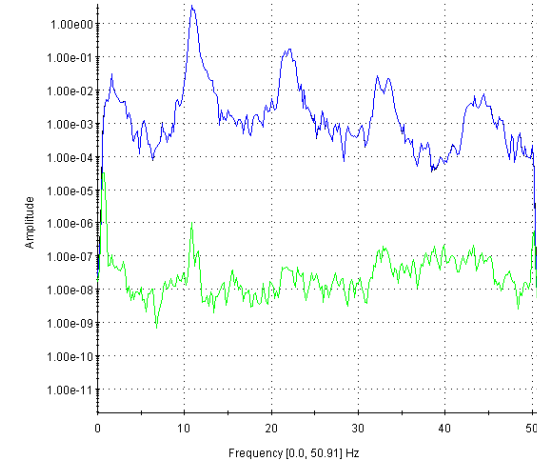

RMS Error Statistics

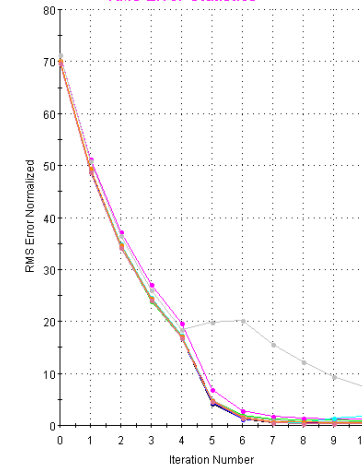

MTS Standard Ball Joint Test System Examples

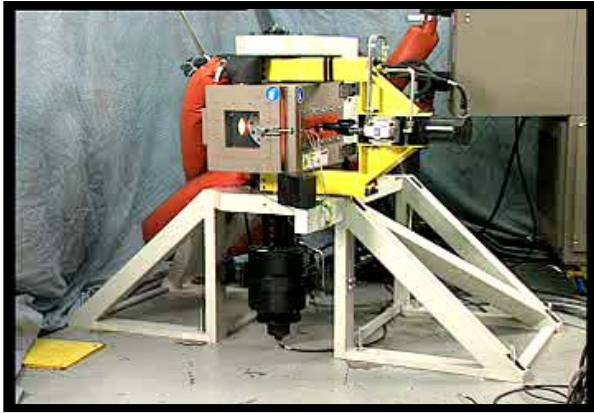

Three Axis Test
(Inner Ball Joints)

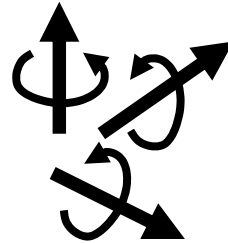
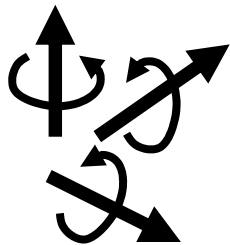

Four Axis Test



Five Axis Test

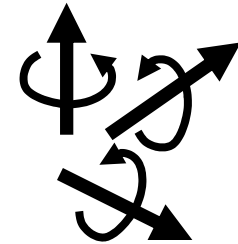

Thank you for your attention